

AEC-Q200

SMPC 系列高温功率电感
SMPC Series High Temperature Power Inductors

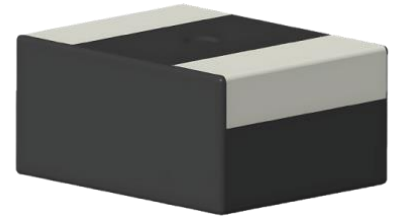

产品应用 Application

- 辅助驾驶 ADAS
- 车载娱乐影音 Vehicle Infotainment
- 车载DC/DC转换 Automotive DC/DC Converters

产品特征 Features

- 耐高温: 155°C 耐温含自发热 (短时间内180°C *对于155 °C以上的温度, 短时间内180 °C以下可以使用, 具体条件请咨询我们。)
High Heat Resistance : Operation up to 155 °C including self-heating.(180 °C short time *Please contact for possible to use over 155 °C condition. Temperature up to 180 °C may possibly be used)
- 高可靠性: 通过采用一体化结构享有卓越的抗震性, 可满足苛刻的车载要求
High Reliability : High vibration resistance as result of newly developed integral construction ; under severe reliability conditions of automotive and other strenuous applications
- 卓越的直流重叠特性: 通过采用金属磁性材料享有高度的磁性饱和
High Bias Current : Excellent inductance stability using ferrous alloy magnetic material
- 低噪音: 通过采用金属磁性材料合成磁芯形成的无缝隙一体化结构
Low Audible (Buzz) Noise : A gapless structure achieved with metal composite core
- 高能效: 可减少绕线的低直流电阻磁芯的涡流损耗
High Efficiency : Low DC resistance of winding and low eddy-current loss of the core
- 温度特性: 因环境温度导致的直流重叠特性变化小
Temperature stability : Excellent inductance stability over broad temp. range
- 符合AEC-Q200
AEC-Q200 compliant

产品规格型号表示方法 How to Order

SMPC252012AF - **1R0** **M** **C**
(1) (2) (3) (4)

- (1) 系列名称 Series Name
- (2) 电感感值 Inductance(μH)
- (3) 精度误差 Tolerance
- (4) 内部代码 Internal Code

外型尺寸 Dimensions

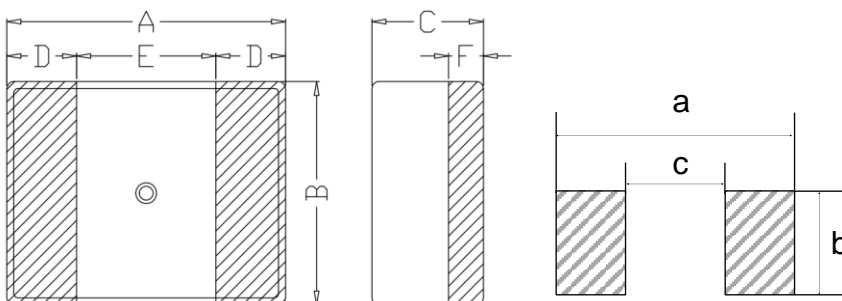

Type	A	B	C	D	E	F	a	b	c
SMPC252012AF(mm)	+0.3 2.5 -0.0	+0.3 2.0 -0.0	1.2±0.1	0.7±0.3	1.1 Typ.	0.45 Ref.	3.0 Typ.	2.4 Typ.	0.9 Typ.

性能参数 Electrical Characteristics

规格型号 Part No.	电感值 Inductance (μH)	直流电阻 R_{DC} (m Ω)		温升电流 I_{rms} (A)		饱和电流 I_{sat} (A)		额定电压 V_{DC} (V)
		Typ.	Max.	Typ.	Max.	Typ.	Max.	Max.
SMPC252012AF-R22MC	0.22 \pm 20%	14.5	16.6	9.0	8.0	10.9	8.7	20
SMPC252012AF-R33MC	0.33 \pm 20%	19.0	22.0	7.1	6.2	8.9	7.0	20
SMPC252012AF-R47MC	0.47 \pm 20%	20.0	23.0	6.3	5.5	7.2	5.8	20
SMPC252012AF-R68MC	0.68 \pm 20%	29.5	34.0	5.2	4.6	6.9	5.5	20
SMPC252012AF-R82MC	0.82 \pm 20%	38.0	45.5	4.5	4.1	6.7	5.3	20
SMPC252012AF-1R0MC	1.00 \pm 20%	44.0	50.5	4.2	3.8	6.6	5.2	20
SMPC252012AF-1R2MC	1.20 \pm 20%	49.0	59.0	3.9	3.5	5.0	4.05	20
SMPC252012AF-1R5MC	1.50 \pm 20%	60.0	69.0	3.6	3.2	4.4	3.5	20
SMPC252012AF-2R2MC	2.20 \pm 20%	75.0	86.0	3.2	2.8	4.0	3.2	20
SMPC252012AF-3R3MC	3.30 \pm 20%	120.0	138.0	2.4	2.1	3.1	2.5	20
SMPC252012AF-4R7MC	4.70 \pm 20%	190.0	218.5	1.9	1.6	2.6	2.1	20
SMPC252012AF-6R8MC	6.80 \pm 20%	220.0	253.0	1.7	1.5	2.1	1.8	20
SMPC252012AF-100MC	10.0 \pm 20%	340.0	391.0	1.4	1.2	1.8	1.4	20

备注 Remark

- 所有测试数据均参考18-25°C环境温度
All test data is referenced to 18-25°C ambient;
- 电感测试条件为用WK3260B或同等设备以1MHz/1.0V测试
Inductance tested at 1MHz/1.0V with WK3260B LCR Meter or equivalent;
- 饱和电流: 加电流时电感量下降小于或等于30%
 I_{sat} : DC current at which the inductance drops 30% from its value without saturation;
- 温升电流: 加电流时产品温度上升小于等于40°C
 I_{rms} : DC current that causes the temperature rise ($\Delta T = 40^\circ\text{C}$) from ambient temperature;
- 工作温度 (包括自身发热): -55°C~+ 155°C
Operating temperature rang (including coil's self-temperature rise): -55°C~+ 155°C.

电流特性曲线 DC BIAS Characteristics

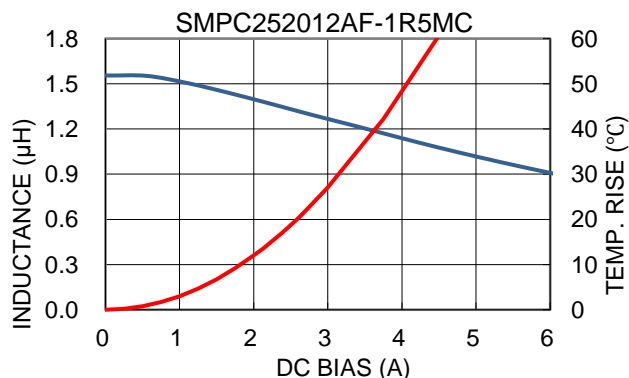
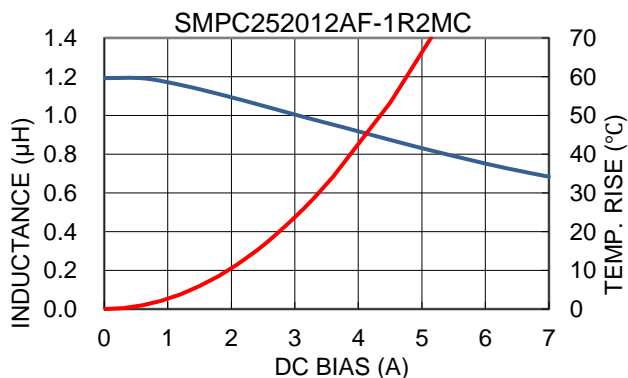
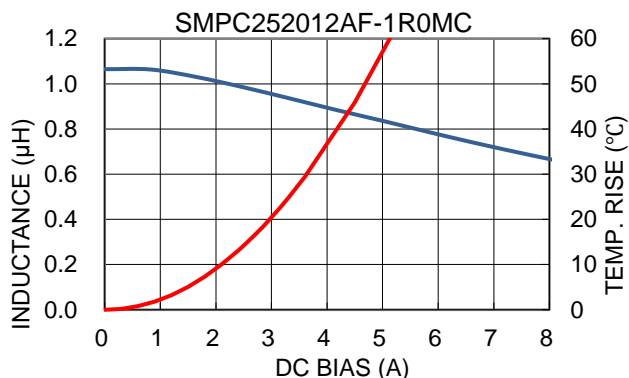
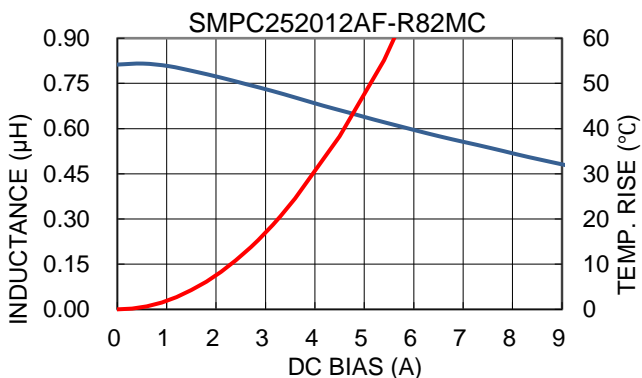
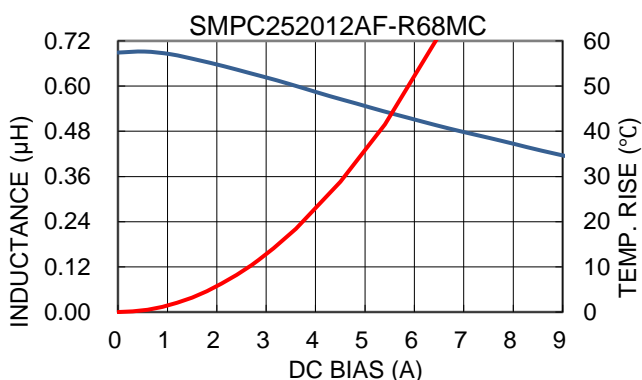
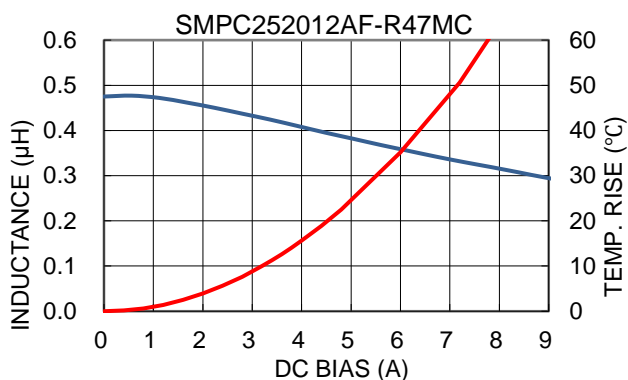
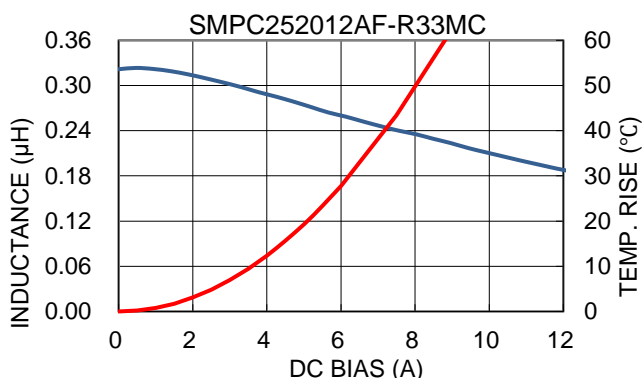
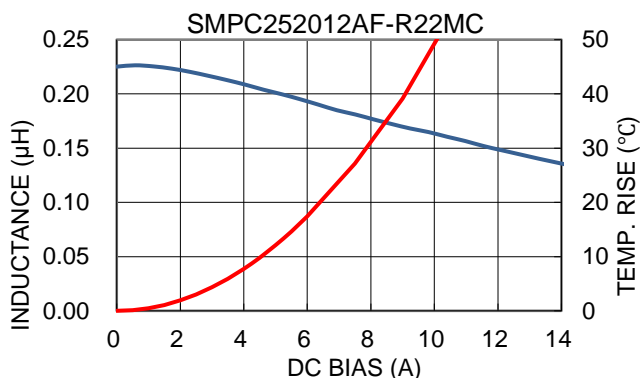

电流特性曲线 DC BIAS Characteristics

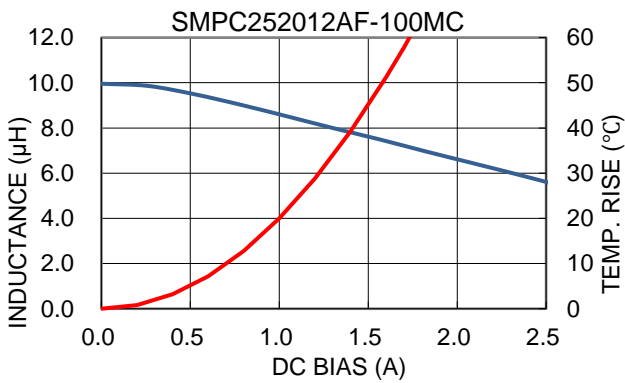
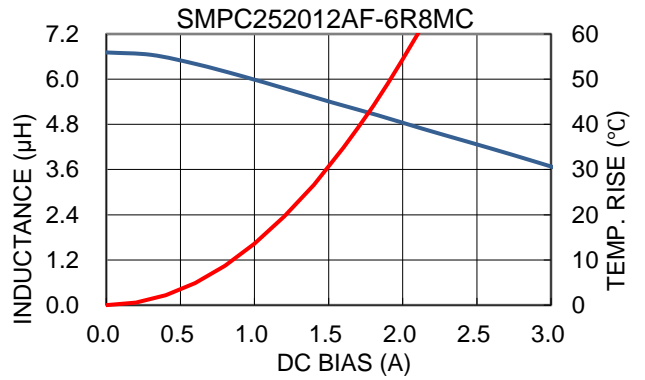
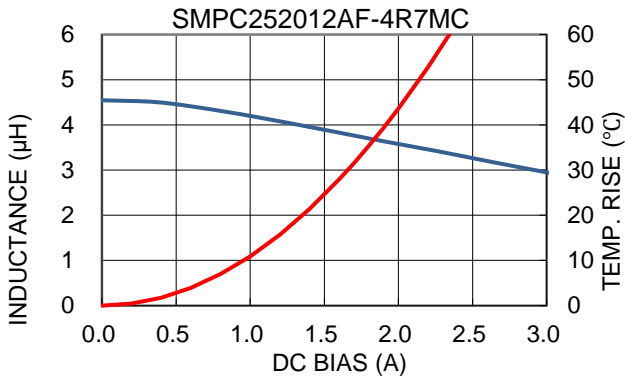
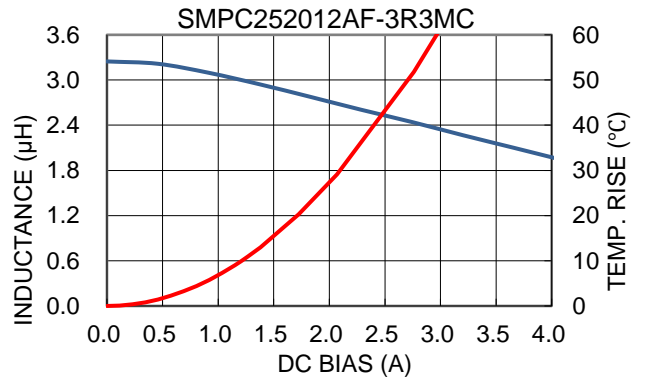
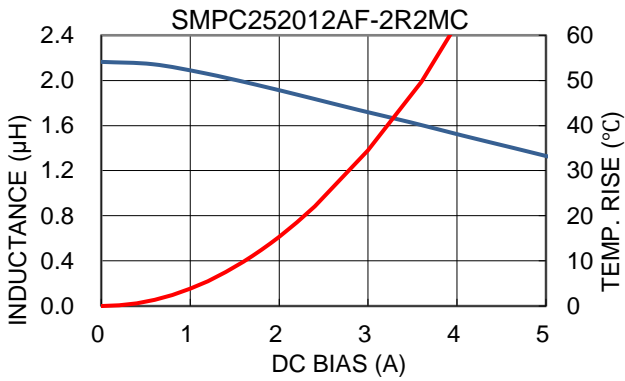

包装材料及规格 Packaging Materials and Specifications

卷轴尺寸图 Reel Size

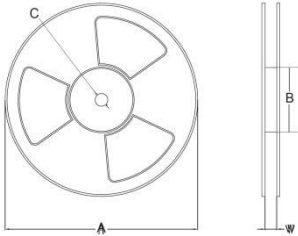

Item	A	B	C	W
Specification(mm)	178	60	12	10

包装带尺寸图 Tape Size

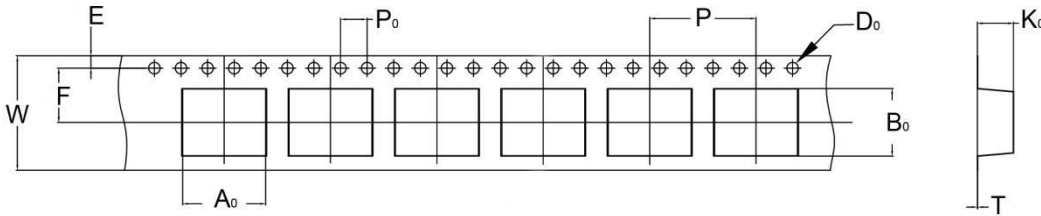

Item	P	W	E	F	D ₀	P ₀	A	B	K ₀	T	pcs/Reel
Specification(mm)	4.0	8.0	1.75	3.5	1.5	4.0	2.50	2.95	1.35	0.22	3000

内外箱标识内容 Inside and Outside Box Identification Content



Made in China

Customer Name: XXXXXXXXXXXX

<HSF/RoHS>

P/O: XXXXXXXXXXXX

2

Customer P/N: XXXXXXXXXXXX

CYGE P/N: XXXXXXXXXXXX

LOT NO: XXXXXXXXXXXX DATE: 2023.06.24 QTY: XXXX PCS



匠心致远 追求卓越 感动人心
Following ingenuity,pursuing,excellence,touching hearts

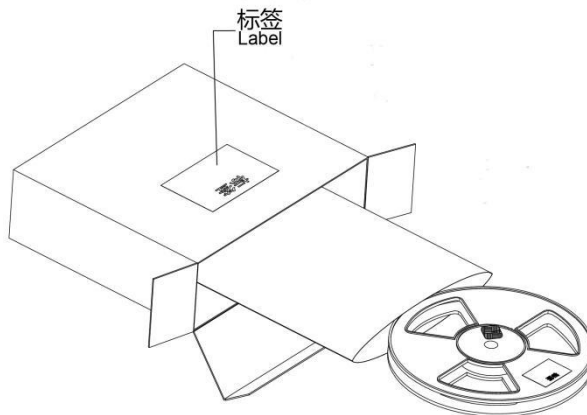
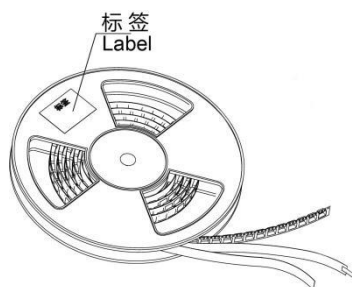

推荐回流焊条件 Recommended Reflow Soldering Conditions

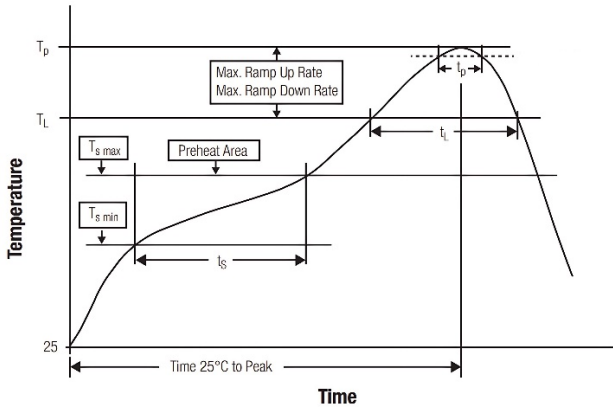

Profile Feature	Lead-Free Assembly
Preheat Temperature Min (T_s min)	150°C
Preheat Temperature Max (T_s max)	200°C
Preheat Time t_s from T_s min to T_s max	60-120 seconds
Average Ramp-Up Rate (T_L to T_P)	3°C /second max.
Liquidous Temperature (T_L)	217°C
Time t_L maintained above T_L (t_L)	60-150 seconds
Peak/Classification Temperature (T_P)	255°C
Time within 5°C of actual peak temperature (t_p)	20-30 second
Ramp-down Rate (T_P to T_L)	6 °C/second max.
Time 25 °C to Peak Temperature	8 minutes max.

储存条件/注意的事项 Storage Conditions/Note Things

- 1、 贮存温度、湿度条件 Storage temperature and humidity conditions :
 - 1.1、 产品包装与载体: -5°C ~ +40°C, 低于60% RH.
Product packing with Carrier tape: -5°C ~ +40°C and less than 60% RH.
 - 1.2、 单独的产品: -20°C ~ +60°C, 低于60% RH.
Product alone: -20°C ~ +60°C and less than 60% RH.
- 2、 产品在6个月内使用(注意:产品一经拆开包装,须尽快使用).
Products should be used within 6 months.
(Note that the product should be used as soon as possible once it is folded) .
- 3、 包装材料应保存在空气中不存在氯或硫的地方.
The packaging material should be kept where no chlorine or sulfur exists in the air.
- 4、 不要用手指触摸电极(焊接端子),因为这可能导致焊接能力的下降.
Do not touch the electrodes (soldering terminals) with fingers as this may lead to deterioration of solderability.
- 5、 个别零件强烈建议使用镊子或真空取料机散装搬运减少磨损和机械冲击.
The use of tweezers or vacuum pick-ups is strongly recommended for individual components.
Bulk handling should ensure that abrasion and mechanical shock are minimized.

**使用相关注意事项(车载等级)**
Application Guidelines (Automotive grade)**注意事项 Safety Precautions**

- 1、使用本产品时,无论用途如何请事先签订交货规格书。本产品介绍中的设计及规格在发生变更时可能不予事先通知,敬请谅解。
When using this product, regardless of the use, exchange product specifications in advance.
The design and specifications in this catalog are subject to change without prior notice.
- 2、请不要超出本目录的规格范围使用产品。
Do not use the products beyond the specifications described in this catalog.
- 3、本目录表示单个零部件的品质和性能。用户在使用时,在贴装于贵公司产品的状态下,请在实际使用条件下进行评估、确认。
This catalog explains the quality and performance of the products as individual components. Before use, check and evaluate their operations when installed in your products.
- 4、在预测到运输设备(火车,汽车,船舶等),通信设备,医疗设备,航空航天设备,电热用品,燃烧燃气设备,旋转设备,防灾防盗设备等上因本产品出现的故障问题而可能导致人身伤害及其他重大损害发生的情况下,请通过以下系统进行故障保护设计以确保安全性。
If a malfunction of this product may result in the loss of human life or other serious damage in transportation equipment (trains, automobiles, ships, etc.), signaling equipment, medical equipment, aerospace equipment, electric heating equipment, combustion and gas equipment, rotating equipment, disaster prevention and security equipment, and other equipment, ensure safety by implementing a fail-safe design with the following system.
*设置保护电路及保护装置的系统。Systems equipped with a protection circuit and a protection device.
*设置冗余电路,出现单一故障时可确保安全的系统。Systems equipped with a redundant circuit or other system to prevent an unsafe status in the event of a single fault.

使用注意事项 Precautions for use**01、异常对策 Provision to abnormal condition**

由于此电源扼流线圈出现超负载以及短路,开放等异常情况时,没有单独的保护功能,故请通过对整个装置采用保护装置或保护电路等措施,确认不会出现冒烟,冒火,绝缘耐性,绝缘电阻等问题。

This power choke coil itself does not have any protective function in abnormal condition such as overload, short-circuit and open-circuit conditions, etc.

Therefore, it shall be confirmed as the end product that there is no risk of smoking, fire, dielectric withstand voltage, insulation resistance, etc. in abnormal conditions to provide protective devices and/or protection circuit in the end product.

02、温度上升 Temperature rise

由于根据实际贴装情况电源扼流线圈的温度上升将有所差异,故请配套贴装时,在确认其处于规定绝缘等级以下的情况下加以使用。

Temperature rise of power choke coil depends on the installation condition in end products. It shall be confirmed in the actual end product that temperature rise of power choke coil is in the limit of specified temperature class.

03、绝缘性能 Dielectric strength

因规定绝缘耐性以上的耐压试验将会导致缩短绝缘寿命,故请加以留意。

Dielectric withstanding test with higher voltage than specific value will damage Insulating material and shorten its life.

04、水分 Water

如沾有水分或咖啡等液体,就会导致绝缘性能的大幅度下降,请不要在射中情况下使用。

This Power choke coil must not be used in wet condition by water, coffee or any liquid because insulation strength becomes very low in such condition.

05、封装 Potting

如用树脂等封装电源扼流线圈,就有可能导致出现铜线绝缘覆膜老化等情况,故请事先与本公司协商。

If this power choke coil is potted in some compound, coating material of magnet wire might be occasionally damaged. Please ask us if you intend to pot this power choke coil.

06、使用机型 Model

在其它组件上以类似的配套方式等使用该电源扼流线圈时,因使用条件上的差异有可能在性能上完全不能得到满足。在这种情况下,烦请与本公司协商。

When this power choke coil is used in a similar or new product to the original one, it might be unable to satisfy the specifications due to difference of condition of usage.

Please ask us if you use this power choke coil in the manner such as above.

07、跌落 Drop

由于跌落等导致电源扼流线圈受到物理上的撞击时, 有可能会使其性能的大幅度下降。因会使线圈架出现断裂, 故请不要使用这种电源扼流线圈。

If the power choke coil receives mechanical stress such as drop, characteristics may become poor (due to damage on coil bobbin, etc.). Never use such stressed power choke coil.

08、蜂鸣声 Buzz noise

在听阈 (20Hz~20kHz) 的频带或突发模式下使用本功率扼流线圈时, 根据动作条件 (通电波形的条件) 可能会产生鸣响声 (蜂鸣声), 根据电路/基板的安装环境听起来可能像异音, 所以请在事先进行确认。

When using this power choke coil in the audible frequency range (20 Hz to 20 kHz) or the burst mode, a buzzing sound may be generated depending on the operating conditions (conditions of the energized waveform) and may be heard as an abnormal sound depending on the circuit/board mounting environment. So, check in advance.

09、耐溶剂性 Solvent

如长时间将本扼流线圈浸泡在甲苯, 二甲苯类的溶剂, 清洗剂, 涂敷剂中, 就有可能导致性能的大幅度下降。

在这种情况下, 请与本公司协商。

If this power choke coil is dipped in the cleaning agent, and the coating agent of the toluene and the xylene system, there is a possibility that the performance decreases greatly. Please ask us if you intend to pot this power choke coil.

10、静电对策 Static electricity measures

①、电路设计 Circuit design

如在电路上有可能会给零部件带来静电时, 请在该功率扼流线圈的前面安装防静电用电容器等ESD对策零部件。或当遇到这种情况时, 与本公司协商。

Please set up the ESD measures parts such as capacitors in the former steps of this power choke coil for static electricity when there is a possibility that static electricity is impressed to the choke coil on the circuit.

Moreover, please consult our company about such a case once.

②、单独使用 Treatment with single

如对该扼流线圈施加200伏以上的电压(工序, 设备), 就有可能导致特性出现变化。单独使用扼流线圈时, 请采取防静电对策。请在200伏以下使用。

(Processes and Equipment) If a voltage of 200 V or more is applied to the power choke coil, the characteristics may change. Take measures against static electricity when handling the power choke coil alone. Operate at 200 V or less.

11、回路基板设计 Printed circuit board design

①、请不要在产品底部的基板最上层设置超过工作电压的焊盘, 通路以确保内部线圈和基板表面的绝缘。

Land pattern and Via which exceed Operating Voltage, should not be placed top layer PWB under the products for keeping isolation between inside coil and surface of PWB.

②、请不要在与扼流线圈底面相对应的印制电路不能上设有布线或金属介层等。

To the opposing part in this power choke coil bottom please install neither pattern nor the beer, etc.

③、请不要使扼流线圈周围的零部件接触到扼流线圈的表面 (顶面, 侧面)。

Parts arranged around this power choke coil do not touch the surface of this power choke coil (Top side and side).

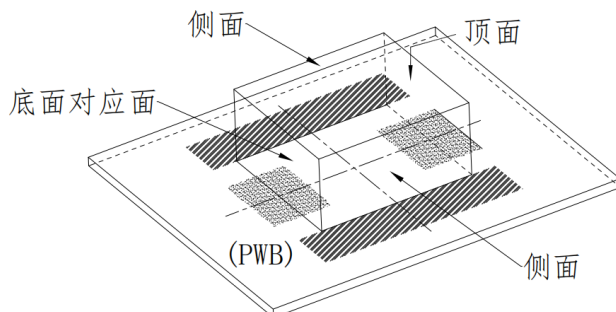

④、本扼流线圈与采用普通集中GAP的铁芯型不同, 在扼流线圈的上下方向拥有漏磁束。为此, 在用于容易受漏磁束影响的零部件或电炉结构时, 请充分加以留意。

This power choke coil is different from the ferrite core-type that installs general concentration GAP.

It has the leakage magnetic bunch distribution of the choke coil to the vertical direction. Please be cautious when using parts and circuit compositions which are easily affected by the leakage flux.

12、其它使用环境 Other using environment

该扼流线圈在设计上没有考虑在下述特殊环境下的使用, 为此请事先对质量及性能所造成的影响充分加以调研后判断是否可以使用的。

This power choke coil is not designed for the use in the following, special environment. Therefore, please do not use it in the following special environment.

*在海风, Cl₂, H₂S, NH₃, SO₂, Nox 等腐蚀性气体浓的场所。

Use in place where a lot of causticity gases such as sea breeze, Cl₂, H₂S, NH₃, SO₂, and NO_x exist.

*在暴露在户外, 直接受到阳光照射的场所。

Use in place where out-of-door exposure and direct sunshine strike.

13、铁芯的缺损及开裂 Core chipping and core crack

本扼流线圈有可能会因来自外部的过度机械性应力而发生铁芯的部分缺损或开裂。此外, 在初期阶段部分铁芯中可能会有不会影响到品质的缺损或开裂。

This choke coil has a possibility to make partial chipping or crack in the core due to excessive mechanical stress from outside, and might have initially a partial chipping and/or cracks that do not affect the quality.

14、保管环境 Keeping environment

如在下述环境条件下保管该扼流线圈, 就有可能导致性能衰减—焊接性等性能蒙受影响, 请避免在保存在这种环境中。

If this power choke coil is kept under following environment and condition, there is a possibility that the performance and soldering decreases greatly.

*在海风, Cl₂, H₂S, NH₃, SO₂, Nox 等腐蚀性气体浓的场所。

Use in place where a lot of causticity gases such as sea breeze, Cl₂, H₂S, NH₃, SO₂, and NO_x exist.

*在暴露在户外, 直接受到阳光照射的场所。

Use in place where out-of-door exposure and direct sunshine strike.

符合AEC-Q200 AEC-Q200 compliant

符合AEC-Q200的产品, 是指已全部或部分实施AEC-Q200中规定的评估试验条件的产品。

The products are tested based on all or part of the test conditions and methods defined in AEC-Q200.

有关各产品的详细规格和具体的评估试验结果等事宜, 请向本公司咨询。此外, 在订购产品时, 请按每类产品签订交货规格书。

Please consult with Panasonic for the details of the product specification and specific evaluation test results, etc., make sure to exchange product specifications for each product when placing an order.